

Qmotion® VECTOR

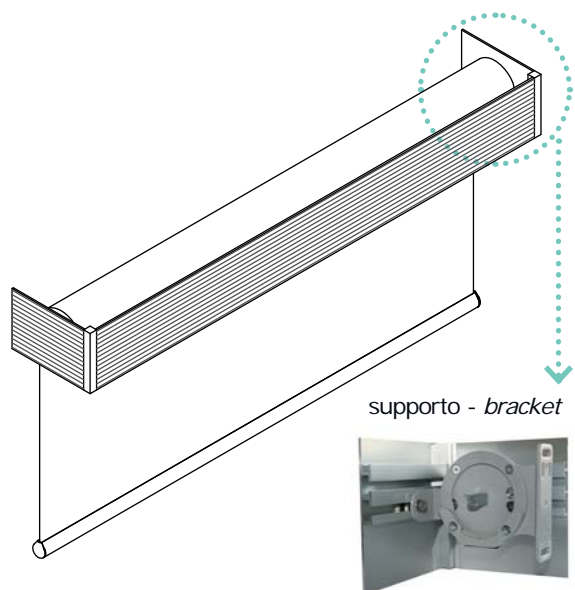

supporto - bracket



dimensioni in mm
dimensions shown in mm

scelta composizioni mantovana choice of components

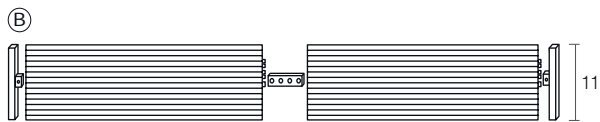
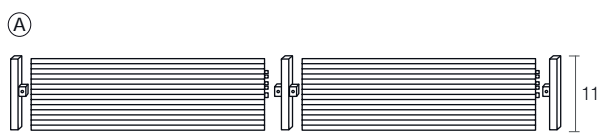

telecomando
monocanale
single channel
remote control



telecomando
multicanale
multi channel
remote control



FMQ50
fondale standard
standard hem bar

varianti - optional

fondale quadro FQ20 in alluminio satinato completo di tappi. Finitura lucida a supplemento

FQ20 satin finish aluminium hem bar with end caps. Polished finish on supplement



CARATTERISTICHE:

Tipo di applicazione: verticale

Ambiente di applicazione: esclusivamente ad uso interno

Mantovana: VECTOR 11 mm in alluminio completa di staffe di fissaggio 80x92 mm in ferro verniciato bianco, grigio, nero. Scelta di differenti composizioni e finiture del profilo. Fino a 300 cm mantovana senza giunzioni.

Rullo di avvolgimento: in alluminio estruso completo di motore

Fondale: FMQ50 in alluminio estruso con tappi in PVC trasparente. A richiesta fondale quadro FQ20 in alluminio satinato completo di tappi

Manovra: motore a batteria 12/24V CC (pile Torcia D), con ricevente radio integrata. Automazione wireless incorporata

Fissaggio: in vano o a parete

CHARACTERISTICS:

Application: vertical

Installation: exclusively for indoor applications

Pelmet: VECTOR H 11 mm with steel powder coated brackets. Choice of components and different pelmet finishes available. Pelmet without joints available up to 300 cm

Roller tube: extruded aluminium with incorporated motor

Hem bar: FMQ50 extruded aluminium hem bar with transparent PVC caps. Satin finish aluminium FQ20 hem bar with end caps on request

Operation: battery operated 12/24 V DC gear motor (D cell batteries) and incorporated receiver for remote control

Mounting: face mounting to wall or lateral mounting in window vane

note - notes

(A) mantovana completa di tappi terminali ed eventuali giunzioni decoro intermedie - *pelmet with end caps and possible decorative joints*

(B) mantovana completa di tappi terminali e giunzione lineare a scomparsa - *pelmet with end caps and hidden linear joint*

(C) mantovana completa di tappi angolari e tappi terminali, disponibile anche nella versione con angoli tagliati a 45°, senza tappi angolari, con giunzione interna 45° cut angles also available without corners, with internal brace joint

tessuti abbinabili - suitable fabrics

per l'utilizzo dei tessuti consultare la sezione dei teli confezionati e/o Tabella "A". Abbinabile ai tessuti della gamma Resstende fino a 410 g/m² e a tutti i tessuti della linea Laylight

for fabric choice consult the fabric section and Tab. "A". Suitable for lightweight fabrics (up to 410 g/m²) from the Resstende collection and for any fabric from the Laylight collection.

supplementi - supplement



1



4



LUCIDO
POLISHED

solo struttura non comprensivi di mantovana e accessori





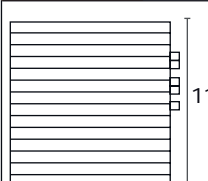
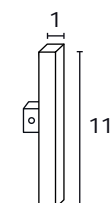
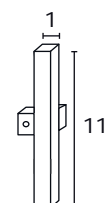
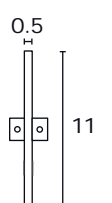
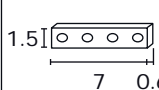





frame only, pelmet and components not included

dimensioni espresse in cm - dimensions shown in cm

N.B. ai prodotti QMotion® verrà applicata una scontistica diversa per la quale vi preghiamo di contattarci
please be advised that as for QMotion® line a separate discount policy will be applied

MANTOVANA E COMPONENTI - PELMET AND COMPONENT PRICES											
mantovana - pelmet (m)		tappo terminale end cap (pz-pcs)		tappo per angolo corner cap (pz-pcs)		giunzione decoro decorative joint (pz-pcs)		giunzione lineare a scomparsa linear joint		giunzione interna per angolo taglio 45° internal brace joint	
satinato satin finish		satinato satin finish		satinato satin finish		satinato satin finish					
lucido polishes finish		cromato chrome plated		cromato chrome plated		cromato chrome plated					
bronzo bronze		bronzo bronze		bronzo bronze		bronzo bronze					
altri colori other colours		altri colori other colours		altri colori other colours		altri colori other colours					
primer											
											

scelta finitura del profilo - pelmet finishes available

	grigio opaco <i>matt grey</i> cod. 104852		grigio chiaro opaco <i>matt light grey</i> cod. 104851		bianco gesso <i>white</i> cod. 104853		grigio scuro opaco <i>matt dark grey</i> cod. 104854
	bianco perla <i>pearl white</i> cod. 104855		alluminio satinato <i>satin finish</i> cod. 104701		bronzo <i>bronze</i> cod. 104857		oro opaco <i>matt gold</i> cod. 104858
	marrone opaco <i>matt brown</i> cod. 104859		alluminio lucido <i>polished finish</i> cod. 104860		primer (tinteggiabile alla posa) <i>primer (may be painted after installation)</i> cod. 104861		

